

# P188627LF

**RP79823▲**  
 Handle Assembly with Set Screw,  
 Button and Allen Wrench  
 Ensemble de manette Avec Vis de  
 fixation, bouton et Llave Allen  
 Mecanismo de llave con Tornillo de  
 Ajuste, Botón y Clé Allen

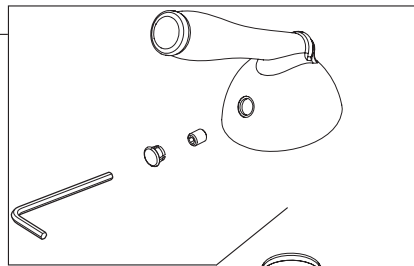

**RP78361▲**  
 Lift Rod Assembly  
 Barra de Alzar  
 Tige de Manoeuvre



**RP78355▲**  
 Cap  
 Embase  
 Casquillo

**RP78353**  
 Bonnet Nut  
 Écrou de chapeau  
 Tuerca bonete

**RP78367**  
 Cartridge  
 Cartouche  
 Cartucho

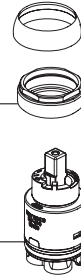

▲ Specify Finish  
 Especifique el acabado  
 Précisez la Finition

**RP51345▲**  
**RP51345▲-1.2**  
 Aerator & Wrench  
 Aireador y Llave  
 Aérateur et Clé

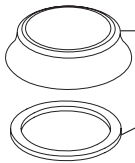
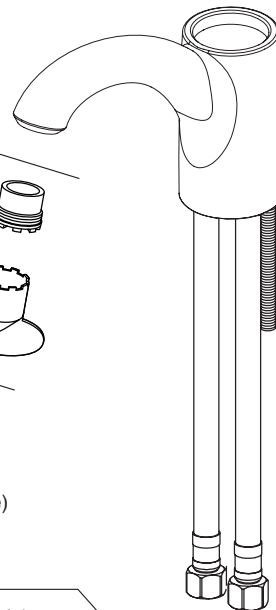
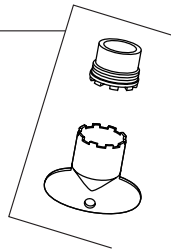

**RP79824▲**  
 Spout Flange & Gasket (1 Hole)  
 Brida y Empaque (1 agujeros)  
 Bride et Joint (1 trous)

**RP82298▲**  
 Escutcheon & Base Plate (3 Hole)  
 Chapetón y Placa de Base (3 agujeros)  
 Boîtier et Plaque de Finition (3 trous)

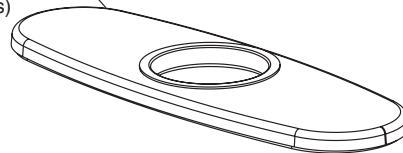

**RP38958▲**  
 Pop-Up with Metal Flange and Plastic Tail Piece Less  
 Lift Rod  
 Drenaje automático con brida de metal y la pieza de  
 cola plástica menos la barra de alzar  
 Renvoi mécanique avec collerette en métal et  
 raccord droit de vidange en plastique sans la tige de  
 manoeuvre

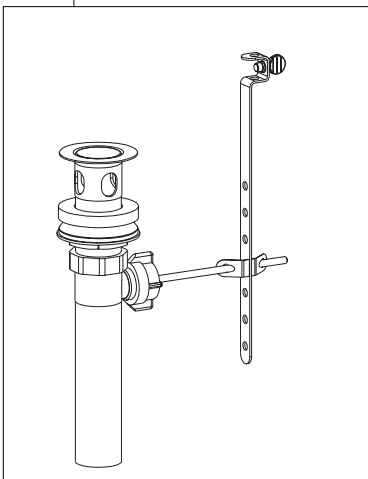

**RP47029**  
 Bracket  
 Abrazadera  
 Support



**RP47030**  
 Nut & Wrench Assembly  
 Ensemble de Tuerca y Llave  
 Écrou et clé

