

MODELS P18550LF , P18550LF-SD & P18550LF-SD-W

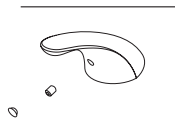

RP70246▲
Lever Handle w/Set Screw and Button
Manija en Palanca con Tornillo de Ajuste y Botón
Manette avec Vis de Calage et Bouton

RP44123▲
Repair Kit
Equipo/Herramientas para reparaciones
Kit de réparation

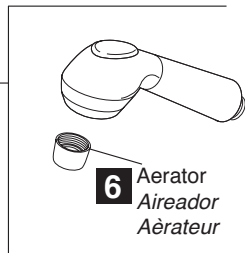

RP70245▲
Wand Assembly
Ensamble de la Cabeza del Rociador
Poignée du bec

6 Aerator
Aireador
Aérateur

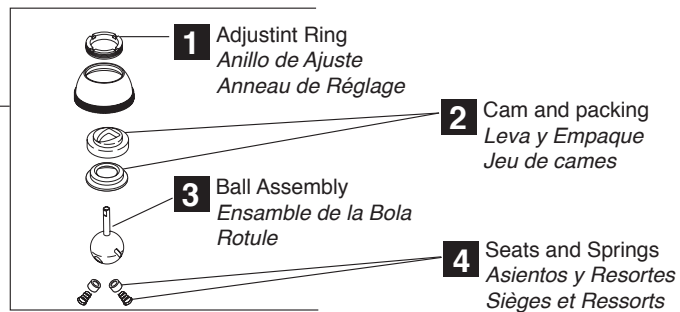

1 Adjustint Ring
Anillo de Ajuste
Anneau de Réglage

2 Cam and packing
Leva y Empaque
Jeu de cames

3 Ball Assembly
Ensamble de la Bola
Rotule

4 Seats and Springs
Asientos y Resortes
Sièges et Ressorts

▲ Specify Finish
Especifique el Acabado
Précisez le Fini

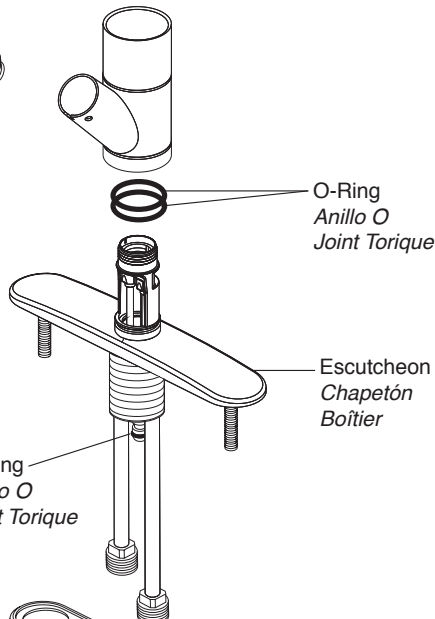

O-Ring
Anillo O
Joint Torique

Escutcheon
Chapetón
Boîtier

5 O-Ring
Anillo O
Joint Torique

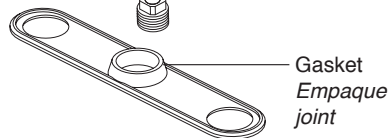

Gasket
Empaque
joint

Locknuts
Contratuercas
Écrous de Blocage

RP70247▲
Hose Assembly
(Includes Gasket & Adapter)
Conjunto de manguera de
(Incluye Junta Y adaptador)
Tuyau souple (Y compris joint & Adaptateur)

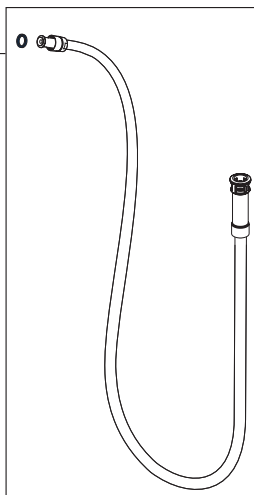

RP70249▲
Dispenser Assembly (complete)
Ensamble del Surtidor (completo)
Distributeur (complet)

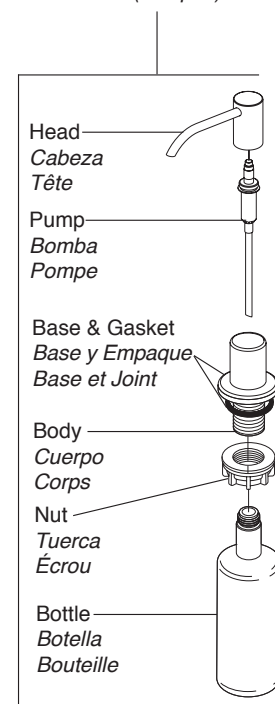

Head
Cabeza
Tête

Pump
Bomba
Pompe

Base & Gasket
Base y Empaque
Base et Joint

Body
Cuerpo
Corps

Nut
Tuerca
Écrou

Bottle
Botella
Bouteille

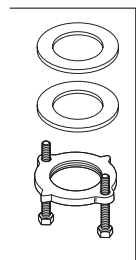

RP70251
Gasket (1), Washer (1),
Nut (1) & Screws (2)
Empaque (1), Arandela (1),
Tuerca (1) y Tornillos (2)
Joint (1), Rondelle (1),
Écrou (1) et Vis (2)

RP63207
Zinc Weights and Screws
Pesas de Cinc y Tornillos
Poids en plomb et vis

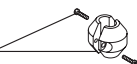

RP5404
Coupling Nuts
(Not supplied in some models)
Tuercas de Acoplamiento
(No proporcionadas en algunos modelos)
Écrous de Raccordement
(Non fournis dans certains modèles)

